

FOX AMAZON

- 35 density high-resilient seat foam
- Goose feather padded back
- Frame strengthened with ply-Wooden (10 year warranty compliance with European norms)
- Modular structure provides unlimited options
- Seating height 38 cm
- Sofa height 84 cm

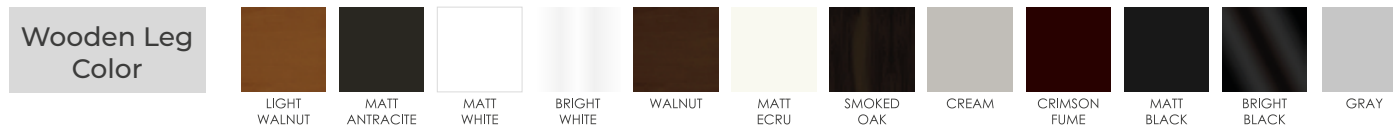

<p>1.5 Sofa</p> <p>KG: 42,0 m³: 0,64</p>	<p>Inter Module</p> <p>KG: 30,0 m³: 0,51</p>	<p>Arm Module (Left)</p> <p>KG: 35,7 m³: 0,61</p>	<p>Arm Module (Right)</p> <p>KG: 35,7 m³: 0,61</p>	<p>Corner Module</p> <p>KG: 36,0 m³: 0,63</p>
--	--	---	--	---

<p>Pouf</p> <p>KG: 20,0 m³: 0,22</p>	<p>Inter 3 Module</p> <p>KG: 55,0 m³: 1,00</p>	<p>Relax Module (Left)</p> <p>KG: 52,0 m³: 0,90</p>	<p>Relax Module (Right)</p> <p>KG: 52,0 m³: 0,90</p>	<p>Arm Module 3 Seater Sofa (Left)</p> <p>KG: 55,6 m³: 1,00</p>
--	--	---	--	---

<p>Arm Module 3 Seater Sofa (Right)</p> <p>KG: 55,6 m³: 1,00</p>	<p>3 Sofa</p> <p>KG: 67,0 m³: 1,19</p>	<p>Felix Armchair Wooden</p> <p>KG: 15,6 m³: 0,28</p>	<p>Artemis Armchair</p> <p>KG: 16,5 m³: 0,61</p>	<p>Picasso Armchair</p> <p>KG: 27,0 m³: 0,88</p>
--	--	---	--	--

OPTION 1

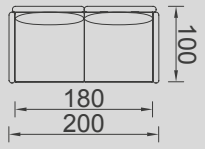

KG: 71,4 m³: 1,22

OPTION 2

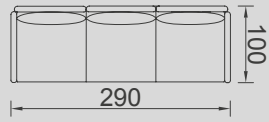

KG: 101,4 m³: 1,73

OPTION 3

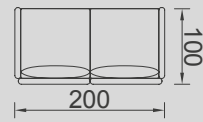
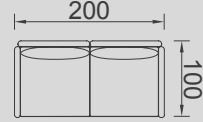

KG: 142,8 m³: 2,44

OPTION 4

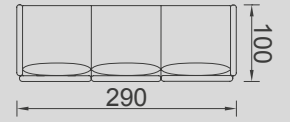
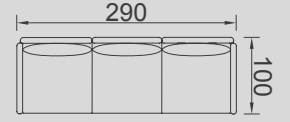

KG: 20,8 m³: 3,46

OPTION 5

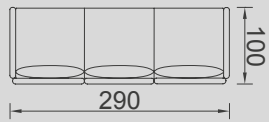
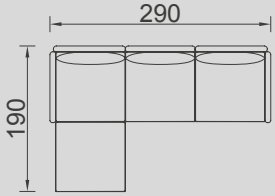

KG: 209,0 m³: 3,63

OPTION 6

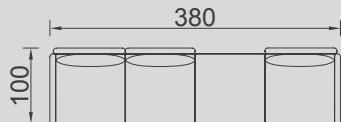

KG: 111,3 m³: 1,83

OPTION 7

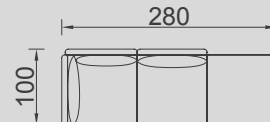

KG: 75,6 m³: 1,22

OPTION 8

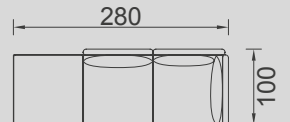

KG: 75,6 m³: 1,22

OPTION 9

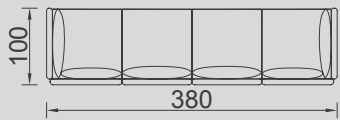
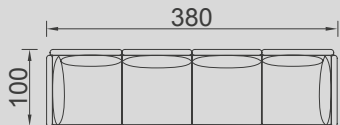

KG: 222,4 m³: 4,00

OPTION 10

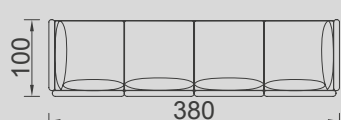
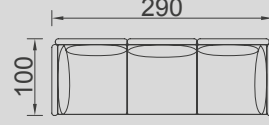

KG: 212,4 m³: 2,73

OPTION 11

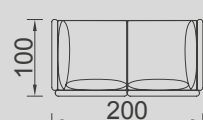
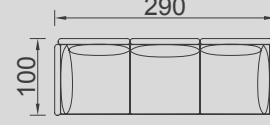

KG: 172,8 m³: 2,95

OPTION 12

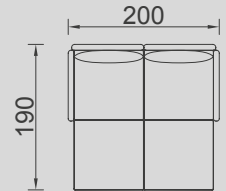

KG: 104,0 m³: 1,80

OPTION 13

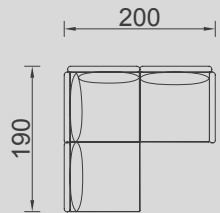

KG: 87,7 m³: 1,50

OPTION 14

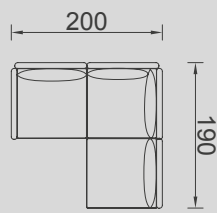

KG: 87,7 m³: 1,50

OPTION 15

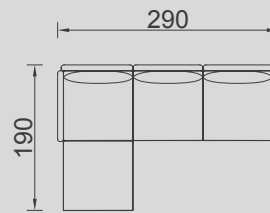

KG: 107,6 m³: 1,90

OPTION 16

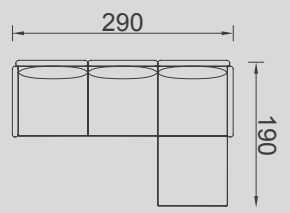

KG: 107,6 m³: 1,90

OPTION 17

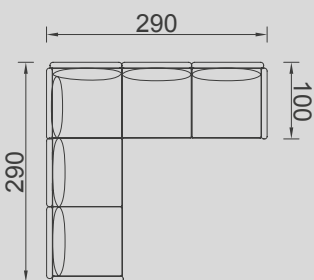

KG: 147,2 m³: 2,63

OPTION 18

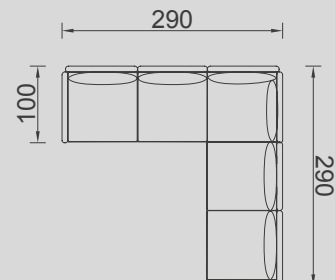

KG: 147,2 m³: 2,63

OPTION 19

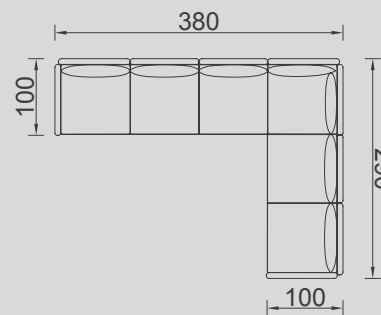

KG: 177,2 m³: 3,13

OPTION 20

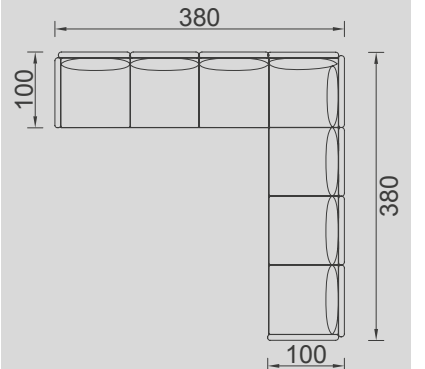

KG: 207,2 m³: 3,63

